

# PMM

## Intermittent motion horizontal cartoner

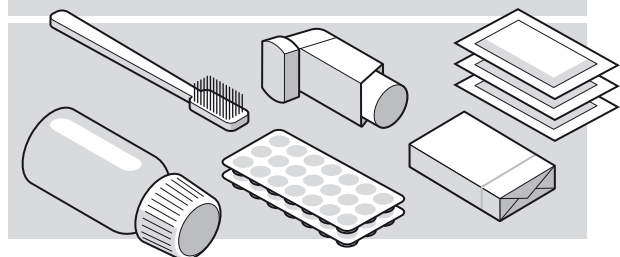
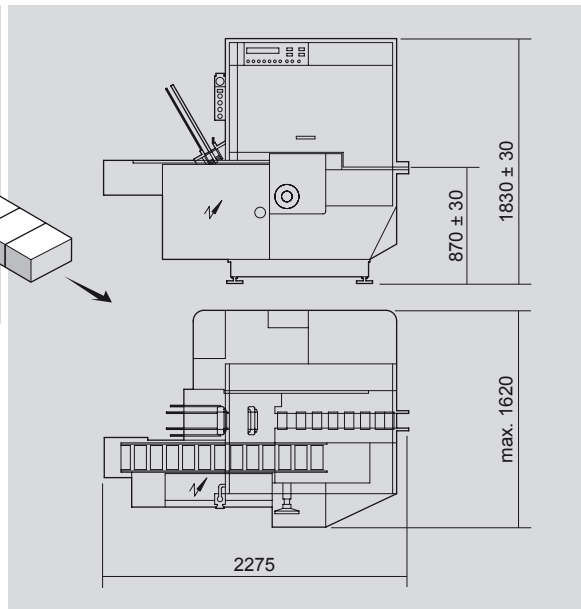
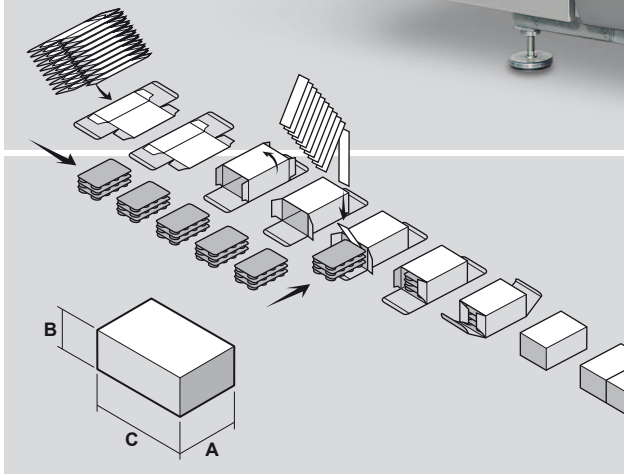

### TECHNICAL DATA

Mechanical speed	<b>STROKES/1'</b>	25÷140
Motors	<b>KW</b>	0,92
Power absorption	<b>KW</b>	1,85 (Hot-melt + 3,9)
Air consumption	<b>NI/1'</b>	16,9
Air pressure	<b>bar</b>	5÷6
Gross weight	<b>kg</b>	~1400
Net weight	<b>kg</b>	~1050
<hr/>		
Size range	<b>min.</b>	<b>max.</b>
<b>A</b>	15	90
<b>B</b>	12	70
<b>C</b>	50	200
<b>A + B</b>	-	140